

cincinnati fan

OEM and Industrial Air Handling Specialist



**TUBE
AXIAL
DUCT
FANS**

7697 Snider Road, Mason, OH 45040-9135

Telephone: 513-573-0600

Visit us at www.cincinnati-fan.com for more information.

Cat. No. TA-310
Supersedes TA-1106



Cincinnati fan

A Company That Stands Behind Its Product

Since the founding of **Cincinnati Fan** in 1956, the company's mission has been to provide quality products at competitive prices, backed by dependable service.

This mission is carried out by specializing in the market for industrial air handling products up to 125 HP. But specialization does not mean the product line is small. **Cincinnati Fan** offers a wide variety of standard and customized products, production flexibility, and customer responsiveness.

Cincinnati Fan has over 170 experienced sales engineers across the U.S. and Canada ready to serve your air handling needs.

Cincinnati Fan can provide:

- Technical evaluation for correct performance conditions.
- Review of air stream and ambient conditions that require special attention.
- Selection of proper components to meet required design specifications.
- Selection of proper accessories.
- System analysis for proper fan design.

Cincinnati Fan operates in a modern facility specifically designed for world class manufacturing enabling us to build standard products to order, including accessories, and ship within 10 to 15 working days.

With support like this, you can be sure your **Cincinnati Fan** product will be well-built and will provide maximum dependability and longevity.

Visit us at www.cincinnati-fan.com for more information.

SPECIFICATIONS FOR TUBE AXIAL FANS

Cincinnati Fan Tube Axial Duct Fans, Model _____, Size _____. Capacity: _____ CFM, _____ Static Pressure at standard conditions. Operating conditions: _____ °F., _____ Ft. Altitude. Prop # _____.

Propellers shall be statically balanced to assure smooth operation. Propeller shall be spark-resistant cast aluminum or steel as specified. Shafts shall be turned, ground and polished steel (or stainless steel). All fan drums shall be 12 gauge on sizes 12" to 30" and 10 gauge on sizes 34" to 48". Drum flanges shall be rolled as an integral part of the drum on sizes 12" to 42". Drum flanges on 48" fans shall be 1½" angle iron rings welded to drum. Drum seam shall be continuously welded.

BAF models shall have sealed fan bearings. TAF, WAF, HTF and WAF/HTF models shall have grease lubricated, heavy-duty, self-aligning, ball bearings mounted in cast iron pillow blocks with grease fittings on outside of fan drum for easy maintenance.

V-Belt drives shall be selected for a minimum of 1.3 times nominal horsepower. Before painting, all steel parts shall be cleaned by detergent wash, phosphatized and painted with oven cured gray enamel.

The following accessories shall be included: (See page 5 for available accessories).

STANDARD FEATURES FOR ALL TUBE AXIALS

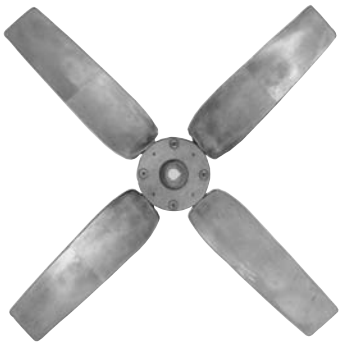

Multi-piece Cast Aluminum Prop available on BAF models, Sizes 12" - 24"



One-piece Cast Aluminum Prop, available on all models.



Optional Steel Props, 12" to 48"
(see page 9)



Adjustable Motor Base and External Grease Fittings
(On all belt driven models except BAF series which have sealed bearings.)

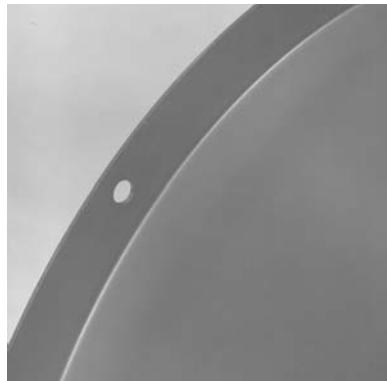

Integral Rolled Flanges
(all 12" - 42" fans)

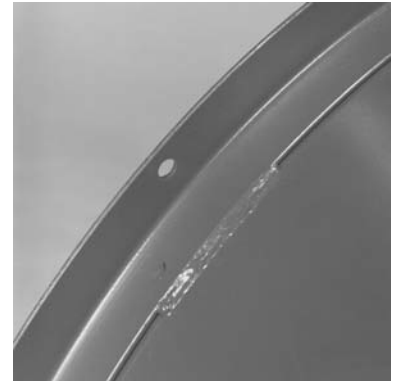

Welded Angle Iron Flanges
(all 48" Fans)

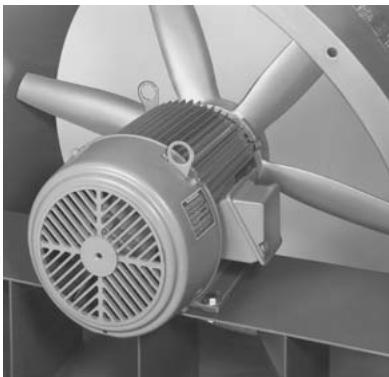

Continuous duty, TEFC motors standard on DDF Models, EXP motors available

DANGER

All fans & blowers shown have rotating parts and pinch points. Severe personal injury can result if operated without guards. Stay away from rotating equipment unless it is disconnected from its power source.

Read operating instructions.

INTERNAL CONSTRUCTION FEATURES

MODEL BAF — For clean, dry air. Maximum temperature 175°F.

- Two sealed ball bearings in cast aluminum housing with grease reservoir.



MODEL TAF – For clean, dry air. Maximum temperature 200°F.

- Heavy duty, independent, cast iron, pillow block, ball bearings with external grease fittings.
- Galvanized steel bearing cover.
- Airfoil (tear drop) belt tube minimizes turbulence and improves efficiency.

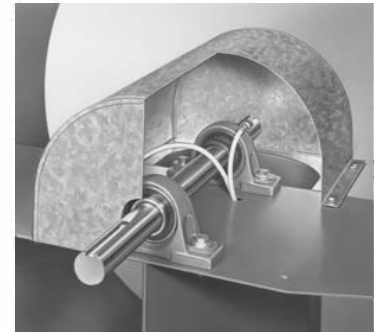
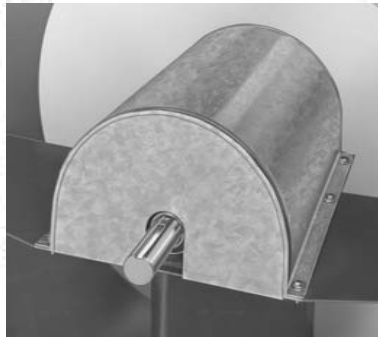

MODEL WAF – For moisture laden air or other air stream contaminants. Maximum temperature 200°F.

- Heavy duty, independent, cast iron, pillow block, ball bearings with external grease fittings.
- Galvanized steel bearing cover, gasketed and sealed. Moisture displacement collar on front of bearing cover is sealed with silicone.
- Airfoil (tear drop) belt tube minimizes turbulence and improves efficiency.

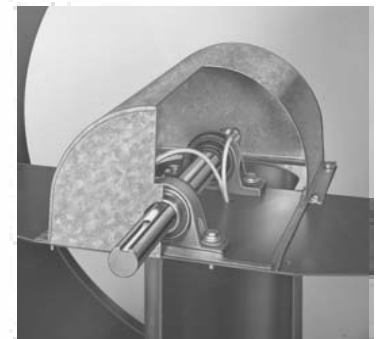
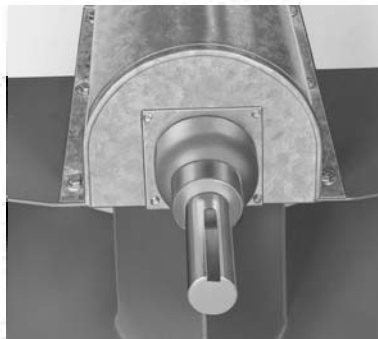

MODEL HTF – For high temperature dry air. Do not use where high moisture concentrations are present.
Temperature range 201°F. to 375°F.

- Heavy duty, independent, cast iron, pillow block, ball bearings with high temperature grease and external grease fittings.
- Galvanized steel insulated bearing cover with large hole around shaft to induce ambient air through insulated belt tube to cool bearings.
- Airfoil (tear drop) belt tube minimizes turbulence and improves efficiency.

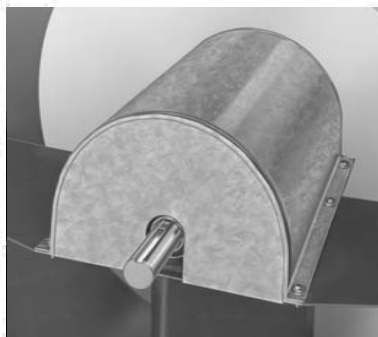

MODEL WAF/HTF – Same as Model HTF except with moisture displacement collar and front seal plate from Model WAF. Temperature range 201°F. to 375°F.

OPTIONAL ACCESSORIES

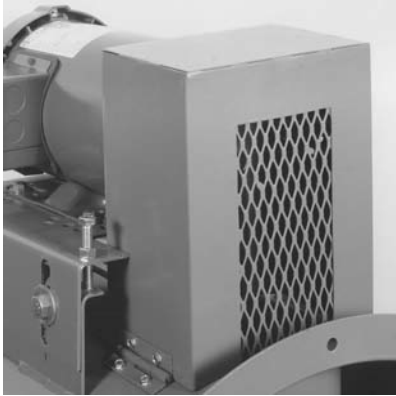

Belt Guard



Galvanized Motor Cover/Belt Guard



Inspection Door



Inlet Bell with Guard

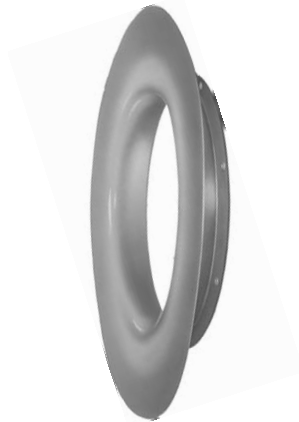

Inlet Bell



Inlet or Outlet Guard
(Expanded metal on 48" Fans)

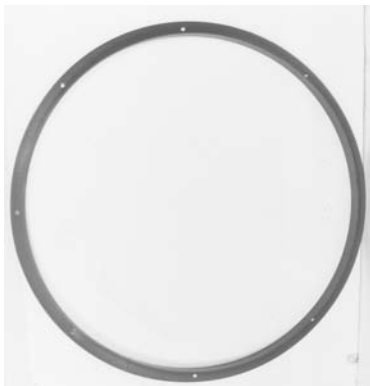

Companion Flange
(Angle Iron)

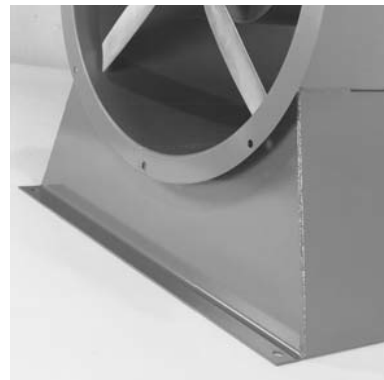

Support Legs

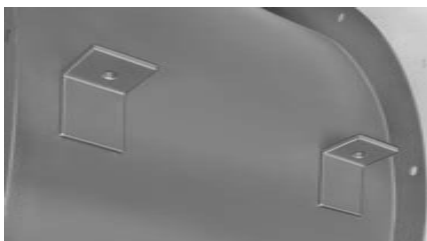

Horizontal

Vertical

Support Clips
(Horizontal or Vertical)



MODEL BAF, BELT DRIVE RATING TABLES WITH CAST ALUMINUM PROPS

CFM and BHP at Static Pressure Shown • Ratings at 70° F., .075 Density, Sea Level
Performance shown is for installation type D-Ducted inlet, Ducted outlet. Power rating (BHP) does not include drive losses.
Performance ratings do not include the effects of appurtenances in the air stream.

FAN SIZE	PROP NO.	FAN RPM	1/8" SP		1/4" SP		3/8" SP		1/2" SP		5/8" SP		3/4" SP		7/8" SP		1" SP		1 1/8" SP		
			CFM	BHP	CFM	BHP	CFM	BHP	CFM	BHP	CFM	BHP	CFM	BHP	CFM	BHP	CFM	BHP	CFM	BHP	CFM
12"	12-4-36	2509	1367	.27	1186	.24															
		2875	1603	.40	1474	.39	1241	.35													
		3350■	1902	.63	1802	.63	1678	.61	1474	.55											
	12-4-30	2195	1347	.24	1180	.25															
		2553	1603	.37	1489	.38	1293	.39													
		2988	1907	.58	1820	.60	1712	.62	1543	.63											
		3317■	2134	.79	2059	.81	1972	.83	1864	.85	1696	.86									
	12-4-20A●	2990	1699	.38	1609	.39	1489	.40	1295	.39											
		3450■	1983	.57	1911	.59	1826	.60	1717	.61	1564	.60	1231	.58							
		3867■	2238	.80	2177	.82	2107	.84	2026	.85	1928	.85	1799	.85	1599	.84					
	12-4-37A●	2663	2148	.56	2000	.57	1703	.55													
		2966	2420	.77	2297	.78	2136	.78													
		3396■	2801	1.16	2700	1.17	2584	1.17	2434	1.17	2084	1.13									
	15"	15-6-36	1725	2327	.25	2108	.26														
			1956	2691	.36	2506	.38	2288	.38												
2323			3261	.59	3105	.61	2947	.63	2766	.64	2509	.64									
2525			3572	.75	3426	.78	3284	.80	3132	.82	2954	.83	2695	.82							
15-4-20A●		2054	2308	.40	2119	.41	1792	.40													
		2333	2660	.57	2514	.59	2314	.60	1972	.59											
		2590	2980	.78	2857	.80	2704	.82	2499	.82	2154	.81									
		3036■	3529	1.23	3431	1.27	3319	1.30	3188	1.32	3026	1.32	2812	1.32	2463	1.29					
		3246■	3785	1.50	3695	1.54	3596	1.58	3482	1.60	3348	1.61	3186	1.62	2972	1.61	2634	1.58			
15-4-30		1875	2288	.23	2085	.25	1774	.25													
		2172	2706	.36	2540	.38	2351	.39	2067	.39											
		2500	3162	.54	3018	.56	2870	.58	2702	.59	2477	.60									
		2775	3541	.73	3410	.76	3280	.78	3143	.80	2987	.81	2789	.82							
		3215■	4143	1.13	4028	1.16	3916	1.18	3803	1.21	3686	1.23	3560	1.25	3417	1.27	3243	1.28	2981	1.27	
18"		18-4-22A●	1750	3217	.36	2939	.38	2567	.39	1019	.36	402	.39								
	2030		3808	.55	3581	.57	3326	.60	2993	.61	2218	.59	773	.58	368	.62					
	2240		4245	.73	4043	.76	3827	.79	3578	.81	3253	.83	2604	.80	1002	.77	581	.82	258	.85	
	2625		5038	1.16	4868	1.20	4693	1.23	4508	1.27	4304	1.30	4067	1.32	3766	1.33	3276	1.31	1528	1.20	
	2815		5426	1.42	5268	1.46	5107	1.50	4940	1.54	4761	1.57	4564	1.60	4337	1.63	4055	1.64	3639	1.63	
	18-6-35	1594	3453	.37	3127	.39	2449	.38	923	.38	397	.42									
		1862	4118	.58	3871	.60	3557	.62	2978	.61	1327	.58	831	.63	368	.68					
		2045	4566	.76	4350	.79	4098	.81	3763	.83	3047	.79	1475	.76	1008	.82	609	.88			
		2415	5459	1.24	5285	1.27	5096	1.31	4882	1.34	4626	1.36	4281	1.36	3557	1.30	1942	1.23	1467	1.30	
	18-4-30	1830	3391	.37	3020	.38	2242	.35	1160	.37	715	.41	358	.44							
		2115	4008	.56	3725	.58	3350	.58	2601	.54	1526	.56	1063	.60	724	.65	418	.68			
		2363	4534	.78	4295	.80	4012	.81	3630	.80	2897	.76	1847	.76	1363	.82	1024	.87	736	.91	
		2722	5286	1.17	5088	1.21	4869	1.23	4616	1.24	4301	1.23	3841	1.20	2917	1.14	2107	1.17	1670	1.23	
		3023	5910	1.59	5736	1.64	5549	1.67	5344	1.69	5110	1.70	4830	1.69	4461	1.66	3867	1.60	2890	1.56	
	18-4-30A●	1590	3531	.41	3196	.41	2564	.39													
		1825	4138	.61	3864	.62	3539	.62	2842	.58											
		2050	4711	.85	4471	.87	4214	.88	3898	.88	3286	.83									
		2330	5416	1.24	5206	1.27	4991	1.29	4759	1.30	4484	1.29	4092	1.26							
2575		6029	1.67	5837	1.70	5646	1.73	5449	1.74	5234	1.75	4986	1.74	4664	1.72	3894	1.61				

■ MOTOR RPM MUST BE 3450 FOR THIS FAN SPEED OR HIGHER. ALL OTHERS MUST BE 1750 RPM MOTORS.

● THESE PROP NUMBERS, WITH AN "A" SUFFIX LETTER, ARE MULTI-PIECE PROPS. ALL OTHERS ARE ONE-PIECE PROPS

(Continued on page 7)

MODEL BAF, BELT DRIVE RATING TABLES

WITH CAST ALUMINUM PROPS (Cont'd)

CFM and BHP at Static Pressure Shown • Ratings at 70° F., .075 Density, Sea Level

Performance shown is for installation type D-Ducted inlet, Ducted outlet. Power rating (BHP) does not include drive losses.

Performance ratings do not include the effects of appurtenances in the air stream.

FAN SIZE	PROP NO.	FAN RPM	1/8" SP		1/4" SP		3/8" SP		1/2" SP		5/8" SP		3/4" SP		7/8" SP		1" SP		1 1/8" SP			
			CFM	BHP	CFM	BHP	CFM	BHP	CFM	BHP	CFM	BHP	CFM	BHP	CFM	BHP	CFM	BHP	CFM	BHP	CFM	BHP
24"	24-6-31	1471	6229	.61	5612	.64	4602	.64	2273	.70												
		1617	6951	.80	6423	.84	5742	.85	4257	.85	2315	.94	1457	1.01								
		1863	8149	1.21	7711	1.26	7221	1.29	6602	1.30	5555	1.29	3372	1.38	2363	1.47						
	24-4-25A ●	1548	6369	.82	5812	.83	4985	.79														
		1950	8256	1.60	7853	1.65	7407	1.66	6861	1.63	6019	1.56										
		2275	9752	2.51	9415	2.58	9061	2.62	8675	2.63	8232	2.61	7676	2.55	6793	2.46						
	24-4-20A ●	1604	5778	.62	5229	.64	4488	.63	2818	.61	1073	.65										
		1750	6391	.80	5910	.83	5328	.83	4465	.81	2522	.80	1118	.84								
		2054	7647	1.28	7255	1.32	6826	1.34	6328	1.35	5686	1.33	4648	1.29	2770	1.30	1561	1.35	663	1.41		
		2200	8243	1.56	7881	1.62	7495	1.65	7065	1.66	6556	1.65	5891	1.63	4810	1.59	3014	1.59	1835	1.65		
		2567	9728	2.46	9423	2.53	9107	2.58	8774	2.61	8415	2.63	8016	2.63	7554	2.62	6986	2.59	6204	2.55		
	24-4-33	1240	6120	.54	5584	.59	4871	.63														
		1392	6993	.76	6524	.81	6009	.86	5252	.89												
		1631	8350	1.20	7942	1.25	7540	1.31	7099	1.37	6542	1.42										
		1823	9430	1.66	9055	1.71	8699	1.78	8334	1.85	7933	1.92	7453	1.97	6752	1.99						
2074		10834	2.43	10490	2.49	10172	2.55	9860	2.63	9539	2.71	9198	2.79	8818	2.86	8363	2.92	7732	2.94			
30"	30-6-22	1205	8495	.83	7495	.85	4807	.83	2426	.86	1331	.91										
		1383	9996	1.25	9196	1.28	8183	1.29	5232	1.24	3089	1.28	2068	1.34	1115	1.40						
		1552	11397	1.76	10701	1.79	9935	1.82	8913	1.83	6062	1.76	3806	1.79	2791	1.86	1957	1.93	1064	1.98		
	30-7-37	953	10084	1.12	9229	1.19	4994	1.01	3325	1.11	2383	1.24	1602	1.36	848	1.47						
		1066	11423	1.54	10775	1.64	9669	1.67	5024	1.43	3724	1.55	2860	1.69	2136	1.83	1462	1.97	778	2.09		
		1226	13287	2.30	12788	2.43	12134	2.52	11071	2.54	6340	2.15	4865	2.26	3965	2.42	3246	2.59	2612	2.75		
		1475	16148	3.94	15772	4.10	15336	4.24	14810	4.36	14121	4.43	13019	4.39	8174	3.74	6530	3.83	5588	4.00		
34"	34-6-29	1266	12338	1.30	10703	1.29	7828	1.30	4452	1.47	2263	1.56										
		1370	13565	1.63	12174	1.64	10112	1.62	6722	1.74	4118	1.91	2171	1.98								
		1608	16307	2.61	15238	2.66	13940	2.65	12167	2.62	9442	2.69	6630	2.93	4636	3.10	2981	3.19	1209	3.22		
		1795	18420	3.61	17504	3.69	16461	3.71	15204	3.68	13551	3.64	11184	3.70	8476	3.95	6386	4.19	4748	4.34		
	34-6-26	953	12763	1.21	11767	1.29	10362	1.30	5525	1.22	3257	1.35	2061	1.46								
		1061	14401	1.64	13558	1.75	12534	1.80	11006	1.79	5987	1.69	3891	1.84	2719	1.96						
		1228	16898	2.48	16204	2.63	15434	2.74	14526	2.79	13325	2.79	11027	2.67	6136	2.68	4549	2.84	3488	2.99		
	1472	20497	4.18	19937	4.39	19347	4.55	18711	4.68	18006	4.77	17193	4.82	16191	4.81	14766	4.73	11214	4.48			
36"	36-6-26	980	14768	1.55	13728	1.64	12517	1.69	10344	1.65	4923	1.65	3421	1.81	2196	1.95						
		1143	17549	2.41	16659	2.53	15748	2.62	14696	2.68	13216	2.67	7676	2.48	5433	2.66	4169	2.85	3107	3.02		
		1378	21510	4.14	20749	4.31	20016	4.45	19267	4.57	18460	4.65	17531	4.70	16341	4.70	14241	4.57	8460	4.40		
42"	42-6-26	821	17850	1.57	15950	1.64	12841	1.62	6967	1.57	4038	1.70	1265	1.82								
		942	20944	2.33	19419	2.43	17546	2.49	14513	2.44	8984	2.35	5949	2.47	3735	2.63	1010	2.76				
		1144	25997	4.10	24801	4.25	23515	4.37	22037	4.44	20158	4.45	17241	4.36	12361	4.20	9094	4.29	6930	4.46		

● THESE PROP NUMBERS, WITH AN "A" SUFFIX LETTER, ARE MULTI-PIECE PROPS. ALL OTHERS ARE ONE-PIECE PROPS

MODELS TAF, WAF, HTF and WAF/HTF BELT DRIVE RATING TABLES WITH CAST ALUMINUM PROPS

CFM and BHP at Static Pressure Shown • Ratings at 70° F., .075 Density, Sea Level
Performance shown is for installation type D-Ducted inlet, Ducted outlet. Power rating (BHP) does not include drive losses.
Performance ratings do not include the effects of appurtenances in the air stream.

FAN SIZE	PROP NO.	FAN RPM	1/8" SP		1/4" SP		3/8" SP		1/2" SP		5/8" SP		3/4" SP		7/8" SP		1" SP		1 1/8" SP				
			CFM	BHP	CFM	BHP	CFM	BHP	CFM	BHP	CFM	BHP	CFM	BHP	CFM	BHP	CFM	BHP	CFM	BHP	CFM	BHP	
12"	12-4-36	2490	1354	.26	1169	.24																	
		2827	1572	.38	1439	.37																	
		3327	1887	.61	1786	.62	1661	.59	1444	.54													
	12-4-30	2221	1398	.25	1256	.25																	
		2587	1663	.39	1558	.40	1412	.40															
		3000	1956	.60	1872	.62	1775	.63	1643	.63													
15"	15-6-36	1625	2145	.22	1881	.23																	
		1938	2635	.37	2446	.39	2196	.39															
		2250	3113	.58	2957	.60	2784	.61	2562	.62	1943	.56											
		2490	3477	.77	3337	.80	3190	.82	3023	.83	2810	.83	2395	.79									
	15-4-30	1750	2127	.22	1867	.23	837	.19	478	.22													
		2087	2617	.38	2422	.39	2182	.39	1195	.33	737	.35	502	.39	284	.43							
		2423	3096	.58	2931	.60	2757	.61	2544	.61	2169	.59	1062	.52	797	.57	599	.61	415	.65			
		2705	3494	.81	3345	.82	3196	.84	3033	.85	2837	.85	2540	.83	1368	.71	1045	.75	837	.80			
		3163	4134	1.28	4004	1.30	3878	1.32	3750	1.34	3615	1.35	3465	1.36	3285	1.36	3039	1.34	2047	1.16			
		18-6-35	1615	3623	.36	3324	.39	2919	.41														
			1885	4317	.57	4071	.60	3800	.63	3446	.65												
			2087	4830	.76	4609	.80	4379	.83	4118	.86	3776	.88										
2435	5705		1.20	5514	1.24	5325	1.28	5127	1.32	4911	1.36	4659	1.38	4332	1.39	3675	1.35						
18-4-30	1813	3680	.38	3372	.41	2950	.45	1384	.35	836	.42												
	2063	4262	.54	4004	.58	3709	.63	3295	.66	1734	.51	1134	.57										
	2313	4837	.76	4610	.80	4369	.85	4089	.90	3708	.93	2362	.75	1495	.76	1112	.86						
	2660	5627	1.14	5429	1.18	5229	1.23	5017	1.29	4779	1.35	4492	1.40	4078	1.41	2589	1.12	1829	1.13				
	2940	6260	1.54	6080	1.57	5901	1.62	5717	1.68	5522	1.75	5307	1.81	5059	1.87	4743	1.91	4237	1.87				
	24"	24-6-31	1432	5634	.63	4879	.62	3231	.55	1785	.65	1012	.75										
1596			6417	.87	5806	.87	4920	.83	3068	.78	1964	.90	1263	1.02	610	1.11							
1845			7578	1.34	7086	1.35	6508	1.34	5697	1.28	4125	1.19	2806	1.29	2059	1.44	1470	1.57	915	1.68			
24-4-33		1235	6020	.56	5423	.59	4483	.61	1794	.59	1056	.66	440	.73									
		1390	6909	.79	6401	.83	5814	.86	4685	.86	2077	.83	1379	.91	828	.99							
		1596	8074	1.19	7635	1.22	7178	1.27	6636	1.31	5807	1.32	2959	1.22	2099	1.30	1538	1.39	1058	1.48			
		1799	9209	1.69	8816	1.73	8426	1.77	8009	1.82	7525	1.87	6875	1.89	4980	1.79	2971	1.78	2306	1.87			
		2023	10453	2.40	10096	2.43	9752	2.48	9402	2.53	9029	2.59	8612	2.64	8108	2.68	7392	2.69	4825	2.49			
		30"	30-6-22	1212	8440	.81	7262	.83	5015	.79	2856	.82	1610	.91									
				1417	10178	1.27	9290	1.32	8137	1.33	6130	1.27	3984	1.27	2726	1.36	1720	1.46					
1551	11290			1.66	10508	1.72	9592	1.75	8324	1.73	6208	1.65	4347	1.67	3172	1.76	2229	1.88	1316	1.99			
30-7-37	824	8512	.74	6773	.75	2863	.72	1815	.83	939	.93												
	960	10168	1.15	9331	1.22	5182	1.03	3415	1.13	2462	1.25	1680	1.38	933	1.49								
	1048	11211	1.47	10538	1.56	9313	1.58	4702	1.37	3497	1.50	2656	1.64	1937	1.77	1255	1.90	539	2.01				
	1231	13345	2.33	12850	2.46	12202	2.55	11166	2.57	6564	2.17	4937	2.29	4027	2.44	3303	2.61	2668	2.77				
	1453	15896	3.77	15512	3.93	15065	4.07	14517	4.18	13782	4.24	12504	4.16	7560	3.57	6176	3.70	5292	3.87				
	34"	34-6-26	945	12278	1.21	11167	1.28	9483	1.31	5684	1.18	3723	1.19	2516	1.27	1494	1.38						
1036			13642	1.57	12687	1.66	11468	1.72	9329	1.70	5750	1.54	4094	1.57	2968	1.66	2015	1.77	1094	1.90			
1191			15928	2.35	15142	2.46	14250	2.56	13138	2.62	11464	2.61	8164	2.41	5923	2.34	4628	2.39	3636	2.49			
1417			19211	3.90	18575	4.04	17897	4.17	17152	4.28	16297	4.37	15246	4.43	13784	4.41	11256	4.20	8510	3.97			
1665			22774	6.26	22242	6.43	21692	6.59	21115	6.74	20497	6.88	19825	7.00	19071	7.10	18195	7.17	17113	7.19			
36"			36-6-26	966	14668	1.57	13572	1.66	12234	1.70	9852	1.63	4707	1.50	3009	1.63	1828	1.77	801	1.93			
	1116	17249		2.38	16331	2.50	15335	2.58	14139	2.62	12381	2.57	7402	2.29	4845	2.36	3486	2.51	2436	2.68			
	1335	20960		4.00	20202	4.16	19427	4.29	18602	4.39	17682	4.46	16586	4.48	15108	4.43	12159	4.16	7600	3.91			
	1542	24430		6.10	23773	6.30	23115	6.47	22441	6.62	21734	6.74	20976	6.83	20135	6.89	19163	6.90	17955	6.86			
42"	42-6-26	826	17956	1.65	16021	1.71	13243	1.68	8333	1.52	3476	1.52	998	1.75									
		949	21087	2.46	19563	2.57	17667	2.60	15092	2.55	11060	2.37	6038	2.24	2959	2.39	1015	2.68					
		1136	25732	4.14	24560	4.31	23228	4.41	21672	4.46	19780	4.44	17337	4.33	13924	4.11	9527	3.87	5974	3.88			
		1313	30058	6.32	29088	6.53	28028	6.70	26857	6.81	25541	6.88	24034	6.88	22256	6.82	20076	6.68	17274	6.45			
		1453	33451	8.51	32594	8.75	31676	8.96	30685	9.12	29606	9.24	28420	9.32	27096	9.34	25593	9.30	23847	9.20			
		48"	48-6-30	766	23995	2.25	22027	2.46	19711	2.62	16319	2.77	10238	3.00	5897	3.36	3299	3.70	1294	4.02			
917	29296			3.74	27785	4.01	26137	4.25	24241	4.45	21872	4.62	18458	4.79	13135	5.08	8814	5.51	6072	5.93			
1050	33943			5.51	32650	5.84	31291	6.13	29826	6.39	28192	6.62	26287	6.83	23910	7.02	20616	7.23	15912	7.55			
1158	37683			7.30	36521	7.68	35320	8.02	34058	8.33	32705	8.61	31220	8.86	29542	9.10	27563	9.31	25081	9.53			
1356	44490			11.55	43506	12.01	42506	12.44	41479	12.83	40414	13.20	39301	13.55	38122	13.87	36860	14.17	35485	14.45			

■ MOTOR RPM MUST BE 3450 FOR THIS FAN SPEED OR HIGHER. ALL OTHERS MUST BE 1750 RPM MOTORS.

MODELS TAF, WAF, HTF and WAF/HTF, BELT DRIVE RATING TABLES WITH STEEL PROPS

CFM and BHP at Static Pressure Shown • Ratings at 70° F., .075 Density, Sea Level
Performance shown is for installation type D-Ducted inlet, Ducted outlet. Power rating (BHP) does not include drive losses.
Performance ratings do not include the effects of appurtenances in the air stream.

FAN SIZE	PROP NO.	FAN RPM	1/8" SP		1/4" SP		3/8" SP		1/2" SP		5/8" SP		3/4" SP		7/8" SP		1" SP		1 1/8" SP			
			CFM	BHP	CFM	BHP	CFM	BHP	CFM	BHP	CFM	BHP	CFM	BHP	CFM	BHP	CFM	BHP	CFM	BHP		
12"	S11.75-8HD	2625	1582	.37	1473	.39	1282	.40														
		3063	1875	.59	1791	.60	1687	.62	1519	.63												
	S11.75-8XHD ●	3450	2131	.84	2060	.85	1979	.87	1879	.88	1728	.90										
		3881	2412	1.19	2351	1.21	2285	1.22	2210	1.24	2120	1.26	1999	1.27								
15"	MS14.75-8HD	2130	2430	.40	2273	.43	2020	.45	1134	.40	858	.42	683	.46	539	.50	406	.54	270	.58		
		2375	2738	.55	2609	.58	2441	.61	2141	.63	1255	.55	998	.58	828	.62	689	.67	565	.71		
		2730	3179	.82	3075	.86	2953	.90	2799	.93	2567	.96	1729	.85	1334	.84	1135	.88	985	.93		
		2939	3437	1.02	3343	1.06	3236	1.10	3110	1.14	2949	1.18	2698	1.20	1828	1.06	1462	1.05	1265	1.08		
18"	MS17.75-8HD	1830	3719	.57	3534	.59	3289	.59	2850	.58	1449	.52	1053	.57	782	.63	553	.68	336	.73		
		2154	4431	.93	4286	.95	4118	.96	3909	.97	3614	.96	2805	.87	1672	.85	1325	.91	1072	.98		
		2333	4821	1.18	4691	1.20	4545	1.21	4375	1.23	4163	1.23	3866	1.22	3129	1.12	1904	1.06	1541	1.13		
		2593	5384	1.61	5270	1.63	5147	1.65	5009	1.67	4852	1.69	4665	1.69	4424	1.68	4054	1.64	2727	1.43		
24"	X23.50-8HD	1301	5813	.67	5306	.74	4201	.76	2428	.71	1770	.81	1318	.91	950	1.01	626	1.09	325	1.14		
		1500	6815	1.01	6439	1.08	5910	1.15	4820	1.16	3071	1.07	2361	1.16	1888	1.28	1511	1.40	1187	1.51		
		1703	7820	1.45	7516	1.53	7141	1.61	6629	1.69	5717	1.71	3940	1.56	3084	1.62	2556	1.73	2152	1.87		
		1974	9145	2.23	8900	2.32	8620	2.42	8288	2.51	7874	2.60	7294	2.67	6232	2.62	4634	2.44	3811	2.47		
		2333	10885	3.65	10688	3.75	10473	3.85	10235	3.97	9970	4.08	9664	4.19	9299	4.30	8838	4.39	8184	4.42		
30"	X29.625-8HD	1042	8235	.75	7207	.82	4985	.87	3176	.97	2223	1.09	1511	1.21	900	1.33	331	1.42				
		1193	9639	1.10	8886	1.19	7741	1.26	5545	1.30	3902	1.42	2955	1.56	2248	1.70	1654	1.84	1120	1.97		
		1233	10005	1.21	9298	1.30	8284	1.38	6391	1.43	4451	1.52	3387	1.66	2631	1.81	2013	1.95	1469	2.09		
		1514	12534	2.17	12027	2.29	11427	2.40	10672	2.51	9612	2.59	7911	2.64	6132	2.73	5000	2.89	4192	3.06		
		1799	15055	3.58	14653	3.73	14209	3.87	13707	4.00	13123	4.13	12412	4.25	11486	4.34	10177	4.40	8513	4.46		
34"	X33.625-8HD	1036	12229	1.43	11401	1.56	9928	1.66	6705	1.71	4857	1.90	3663	2.13	2684	2.39	1781	2.66	864	2.94		
		1203	14398	2.18	13783	2.34	12955	2.49	11614	2.60	8825	2.64	6649	2.80	5342	3.04	4336	3.32	3471	3.61		
		X33.625-8XHD ●	1446	17502	3.70	17043	3.90	16502	4.09	15836	4.27	14950	4.43	13593	4.54	11200	4.57	8986	4.70	7580	4.95	
	X33.625-8XHDB ●	1609	19565	5.04	19169	5.27	18723	5.49	18206	5.70	17589	5.90	16811	6.07	15743	6.21	14059	6.28	11678	6.32		
36"	X35.625-8HD	902	12851	1.37	11745	1.50	9876	1.57	5006	1.66	3445	1.86	2390	2.06	1485	2.25						
		1044	15152	2.06	14289	2.23	13312	2.36	11481	2.43	6618	2.48	4796	2.73	3685	2.96	2797	3.19	2006	3.41		
	X35.625-8XHD ●	1277	18852	3.66	18196	3.88	17472	4.08	16636	4.24	15588	4.37	14010	4.44	9646	4.42	7115	4.70	5841	4.99		
		1413	20987	4.90	20407	5.15	19785	5.38	19101	5.59	18321	5.76	17380	5.91	16106	6.00	13691	6.00	9314	6.11		
	Y35.625-8HD	1069	18322	3.48	17881	3.71	17378	3.93	16782	4.13	16026	4.32	14912	4.47								
	Y35.625-8XHD ●	1264	21802	5.65	21447	5.92	21061	6.18	20636	6.44	20159	6.69	19607	6.93	18942	7.15	18073	7.34	16670	7.45		
42"	X41.625-8HD	742	15293	1.28	13753	1.43	10840	1.54	5400	1.67	3433	1.85	2124	2.04	1064	2.23						
		875	18452	2.02	17317	2.20	15854	2.37	13464	2.51	8040	2.62	5481	2.83	3988	3.05	2849	3.27	1890	3.50		
		1044	22375	3.33	21498	3.56	20498	3.77	19296	3.98	17703	4.16	15017	4.30	10008	4.43	7443	4.67	5895	4.93		
	X41.625-8XHD ●	1215	26290	5.16	25568	5.42	24784	5.68	23915	5.93	22922	6.17	21738	6.40	20210	6.60	17888	6.77	13529	6.88		
	Y41.625-8HD	1055	24535	5.00	24031	5.29	23467	5.56	22822	5.83	22066	6.10	21142	6.34	19944	6.57	18234	6.75	15614	6.86		
	Y41.625-8XHD ●	192	27837	7.13	27406	7.45	26938	7.76	26423	8.08	25851	8.38	25204	8.68	24456	8.97	23564	9.24	22455	9.49		
48"	X47.312-8HD	734	21954	2.14	20073	2.34	17317	2.51	11524	2.60	7048	2.81	4676	3.06	2923	3.32	1449	3.57				
		875	26742	3.52	25328	3.77	23635	4.00	21399	4.20	17765	4.34	12086	4.47	8668	4.73	6497	5.02	4825	5.33		
	X47.312-8XHD ●	1024	31704	5.52	30564	5.83	29295	6.12	27834	6.39	26065	6.63	23723	6.84	20109	6.97	15062	7.11	11579	7.38		
1127		35101	7.29	34090	7.63	32994	7.96	31782	8.27	30408	8.56	28788	8.83	26760	9.06	23957	9.24	19733	9.35			
	Y47.312-8XHD ●	1055	35323	8.54	34785	8.92	34194	9.30	33535	9.66	32789	10.01	31924	10.35	30892	10.66	29605	10.94	27895	11.17		

- MOTOR RPM MUST BE 3450 FOR THIS FAN SPEED OR HIGHER. ALL OTHERS MUST BE 1750 RPM MOTORS.
- XHD AND XHDB PROPELLERS ARE NOT STOCK ITEMS. CONSULT YOUR LOCAL CINCINNATI FAN SALES REPRESENTATIVE FOR CURRENT SHIPMENT LEAD TIMES.

MODEL DDF, DIRECT DRIVE RATING TABLES

WITH CAST ALUMINUM PROPS

CFM and BHP at Static Pressure Shown • Ratings at 70° F., .075 Density, Sea Level

Performance shown is for installation type D-Ducted inlet, Ducted outlet.

Performance ratings do not include the effects of appurtenances in the air stream.

FAN SIZE	PROP NO.	FAN RPM	1/8" SP		1/4" SP		3/8" SP		1/2" SP		5/8" SP		3/4" SP		7/8" SP		1" SP		1 1/8" SP	
			CFM	BHP	CFM	BHP	CFM	BHP	CFM	BHP	CFM	BHP	CFM	BHP	CFM	BHP	CFM	BHP	CFM	BHP
12"	12-6-24	3450	2035	.39	1976	.40	1912	.42	1840	.44	1755	.46	1643	.48	1439	.50	773	.46	616	.47
	12-4-30	3450	2425	.55	2344	.57	2270	.60	2198	.63	2122	.66	2037	.70	1933	.73	1759	.74		
15"	15-6-25	1750	2032	.17	1869	.18	1608	.19	650	.19	416	.22								
	15-6-36	1750	2365	.21	2161	.24	1831	.25												
	15-6-43	1750	2748	.40	2536	.43	2175	.45												
	15-6-25	3450	4204	1.21	4137	1.23	4068	1.25	3997	1.28	3922	1.30	3842	1.33	3757	1.36	3663	1.39	3559	1.42
	15-4-30	3450	4593	1.35	4473	1.38	4363	1.41	4257	1.43	4151	1.45	4043	1.47	3929	1.46	3804	1.48	3662	1.48
	15-6-36	3450	4954	1.53	4850	1.56	4750	1.59	4652	1.64	4554	1.68	4453	1.72	4347	1.77	4234	1.81	4109	1.86
18"	18-4-22A●	1750	3193	.28	2914	.31	2554	.32	1100	.27										
	18-6-25	1750	3427	.27	3204	.31	2944	.35	2556	.38	1329	.36	893	.39						
	18-6-35	1750	3918	.38	3654	.41	3350	.44	2800	.45										
	18-6-36	1750	4537	.66	4276	.69	3960	.70												
	18-6-43	1750	4915	.76	4689	.79	4469	.83	4222	.86	3873	.88								
24"	24-4-16A●	1750	5881	.62	5445	.65	4931	.65	4171	.65	2652	.63	1630	.61	946	.60				
	24-4-20A●	1750	6795	.89	6335	.95	5855	1.01	5252	1.03	3778	.86	1486	.85						
	24-6-31	1750	7196	.86	6599	.95	5819	1.01	4489	1.04	2880	1.08	1851	1.18						
	24-4-33	1750	9104	1.53	8680	1.61	8272	1.69	7840	1.76	7331	1.81	6593	1.81						
	24-6-41	1750	10256	2.28	9885	2.36	9535	2.45	9182	2.54	8809	2.62	8391	2.70	7884	2.75	7138	2.74		
30"	30-6-22	1150	8048	.59	6800	.60	3716	.54	1894	.63	587	.72								
	30-4-41	1150	12034	1.47	11234	1.54	10297	1.64	8783	1.71										
	30-7-37	1150	12405	1.92	11847	2.03	11050	2.10	8803	1.96	4903	1.83	3855	1.97	3073	2.13	2398	2.28	1770	2.43
	30-6-22	1750	13155	1.93	12466	2.04	11756	2.11	10954	2.14	9928	2.11	8213	1.99	5550	1.91	4101	2.04	3111	2.19
	30-4-41	1750	18993	5.14	18474	5.17	17961	5.24	17438	5.35	16890	5.48	16298	5.62	15632	5.77	14837	5.91	13756	6.01
	30-7-37	1750	19277	6.49	18978	6.69	18649	6.88	18283	7.05	17868	7.20	17381	7.32	16779	7.39	15960	7.39	14442	7.15
34"	34-6-29	1150	12035	1.11	10249	1.12	5128	1.14	2685	1.29										
	34-6-26	1150	15530	2.01	14663	2.12	13691	2.20	12430	2.23	10025	2.12	6455	1.97	4944	2.07	3887	2.21		
	34-6-29	1750	19293	3.77	18570	3.89	17701	3.96	16573	3.98	14834	3.91	10898	3.78	7686	4.02	5877	4.27	4440	4.49
	34-6-26	1750	24369	6.82	23809	7.02	23250	7.20	22682	7.37	22093	7.52	21471	7.65	20797	7.76	20046	7.84	19174	7.87
36"	36-6-25	1150	13927	1.44	12059	1.46	7931	1.35												
	36-6-26	1150	18223	2.45	17344	2.60	16401	2.70	15315	2.77	13904	2.77	11430	2.64	6850	2.42	4606	2.49	2967	2.61
	36-6-25	1750	22339	4.88	21488	5.05	20497	5.15	19291	5.17	17704	5.08	15342	4.89	11882	4.77	8891	4.95	6678	5.22
	36-6-26	1750	28485	8.29	27911	8.56	27340	8.81	26763	9.03	26173	9.23	25563	9.39	24924	9.54	24245	9.65	23510	9.74
42"	42-6-26	850	19071	1.70	17246	1.79	14816	1.79	9922	1.60	4720	1.57	1839	1.73						
	42-6-26	1150	26822	4.04	25589	4.23	24277	4.37	22813	4.45	21074	4.46	18777	4.37	15098	4.10	10069	3.82	6781	3.86
48"	48-6-19	850	20743	1.60	18397	1.72	15649	1.80	11489	1.78	4067	1.66								
	48-6-30	850	27893	2.88	26242	3.14	24333	3.36	21922	3.54	18339	3.71	12711	4.01	8430	4.43	5606	4.84		
	48-6-19	1150	29479	3.79	27777	4.00	26066	4.17	24264	4.31	22268	4.42	19913	4.47	16827	4.44	12027	4.26	6177	4.10
	48-6-30	1150	38684	6.81	37540	7.20	36340	7.56	35058	7.89	33663	8.19	32105	8.46	30309	8.70	28134	8.93	25321	9.16

● THESE PROP NUMBERS, WITH AN "A" SUFFIX LETTER, ARE MULTI-PIECE PROPS. ALL OTHERS ARE ONE-PIECE PROPS.

MOTOR FRAME SIZE LIMITS FOR MODEL DDF FANS

FAN SIZE	MOTOR FRAME SIZES	
	Min. Frame	Max. Frame
12	56①	56 ①
15	56①	145T ①
18	56	145T
24	56	215T
30	143T	215T
34	143T	256T
36	143T	256T
42	182T	256T
48	213T	286T

① If fan is ordered with an EXP (Explosion Proof) motor, the motor conduit box must be removed and shipped loose with the fan. It will not fit inside the drum. It must be installed externally by the end user and all wiring connections, from the motor to the conduit box, must meet all applicable codes.



DIMENSIONS and SPECIFICATIONS

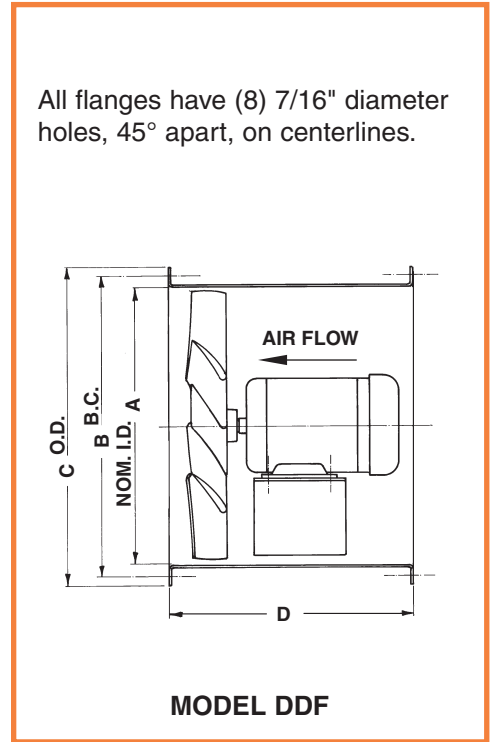
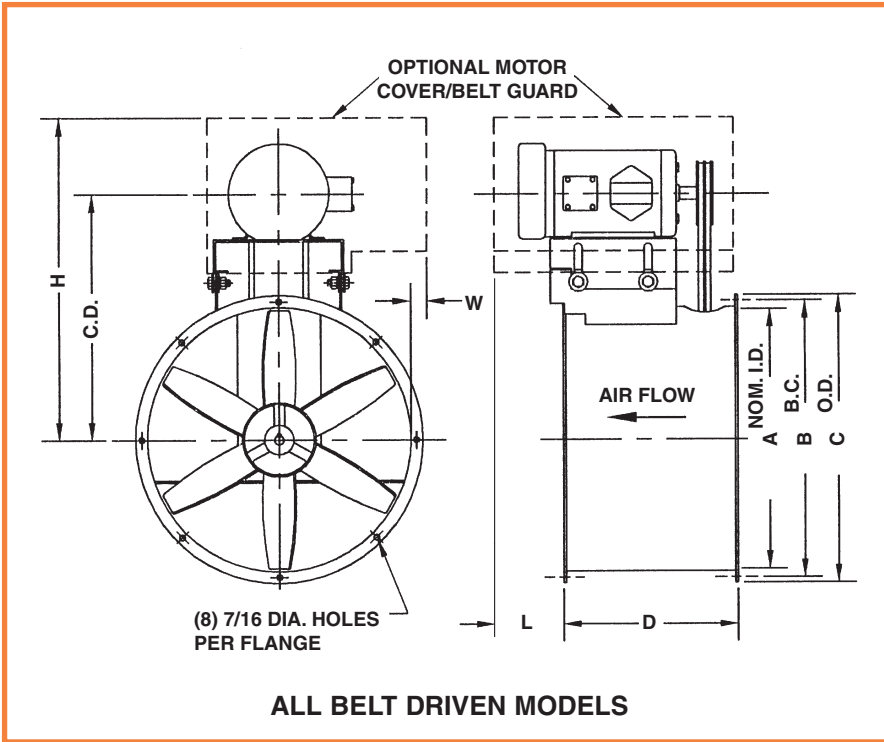

DIMENSIONS IN INCHES ± 1/8"

Dimensions subject to change without notice.

FAN SIZE	MOTOR HP	ALL MODELS			D		Fan Shaft O.D.		Fan Shaft Key Size		OPT. MOTOR/BELT COVER ①		
		A	B	C	Model BAF only	All other models	Model BAF only	TAF, WAF, HTF & WAF/HTF	Model BAF only	TAF, WAF, HTF & WAF/HTF	H Max.	W Max.	L Max.
12	All	12	13 1/8	14 1/16	12	20	3/4	1	3/16	1/4	18 9/16	3 1/16	8
15	All	15	16 1/8	17 1/16	12	20	3/4	1	3/16	1/4	20 1/2	3 3/4	8
18	All	18	19 1/8	20 1/16	12	20	3/4	1	3/16	1/4	22 5/16	2 5/16	8
24	All	24	25 13/16	26 11/16	16	21	1	1 3/16	1/4	1/4	28 7/8	—	8 1/2
30	All	30	31 3/4	32 11/16	16	22	1	1 7/16	1/4	3/8	32 3/16	—	8 9/16
34	All	34	35 11/16	37 1/4	16	26	1	1 7/16	1/4	3/8	34 3/8	—	8 9/16
36	All	36	37 7/8	39 1/4	16	28	1	1 7/16	1/4	3/8	35 13/16	—	8 1/2
42	All	42	43 9/16	45 1/4	16	29	1	1 7/16	1/4	3/8	39 1/16	—	8 1/2
48	3 to 7 1/2	47 3/4	49 5/8	51	—	31	—	1 7/16	—	3/8	41 5/8	—	—
	10 to 15				—		1 15/16	—	1/2	42 3/8	—	—	

① All models; height, width and length vary with motor frame sizes. Dimensions shown are the maximums for each fan size.

Center Distance Dimensions in Inches (C.D.) & Motor Frame Size Limits for All Belt Driven Models

APPROX. SHIPPING WEIGHT LESS MOTOR

FAN SIZE	MOTOR FRAME SIZE									
	56		143T-145T		182T-184T		213T-215T		254T-256T	
	MIN. ②	MAX.	MIN. ②	MAX.	MIN. ②	MAX.	MIN. ②	MAX.	MIN. ②	MAX.
12	11 15/16	13 1/8	11 15/16	13 1/8						
15	13 7/8	15 1/16	13 7/8	15 1/16						
18	15 5/8	16 13/16	15 5/8	16 13/16	15 3/4 ③	16 15/16 ③				
24	18 9/16	19 3/4	18 9/16	19 3/4	19 9/16	20 3/4	20 3/16	21 3/8		
30			21 3/4	23	22 3/4	24	23 9/16	24 13/16		
34			23 15/16	25 3/16	24 15/16	26 3/16	25 11/16	26 15/16		
36			25	26 1/4	26	27 1/4	26 3/4	28		
42			27 15/16	29 3/16	28 15/16	30 3/16	29 11/16	30 15/16	30 5/16 ④	31 5/16 ④
48 ⑤					32 3/16	33 7/16	32 15/16	34 3/16	33 13/16	34 13/16

② Minimum center distances include 1/2" for belt installation. ④ 254T Maximum frame size.
 ③ 182T Maximum frame size. ⑤ Not available in Model BAF.

FAN SIZE	MODEL BAF	MODELS TAF, WAF, HTF & WAF/HTF	MODEL DDF
12	36	70	30
15	55	75	50
18	68	85	64
24	108	145	80
30	130	180	95
34	180	270	160
36	190	295	180
42	225	410	205
48	—	530	270